

★ OFFICIAL ★  
RUBY STAR  
SOCIETY  
PATTERN CO.

# SANTA HAT

*project sheet*



PS RS5028

# CUTTING INSTRUCTIONS

Print and cut out pattern pieces on pages 4-7, being sure your printer scale is set at 100% (there is a square to measure to check). Tape hat pieces together as shown in diagram.

From Outer Fabric, with fabric folded, cut (1) Hat on fold. Cut notch at bottom edge fold.



From Snuggles Lining, with one short end folded, cut (1) Hat on fold. Cut notch at bottom fold. From remaining fabric, cut (1) Pom Pom and (1) Band 8" x 24".

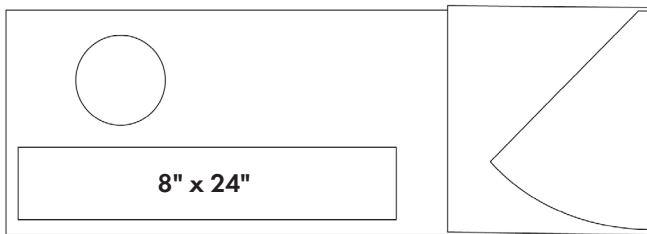

# SEWING INSTRUCTIONS

All seam allowances  $\frac{5}{8}$ " unless otherwise noted.

Bring straight edges of Outer Fabric Hat piece right sides together and pin. Stitch edge, backstitching at beginning and end.

Press seam open. Do not turn hat right side out.



Repeat with Snuggles Hat, finger pressing instead of pressing with an iron. Trim seam allowance to reduce bulk and turn right side out.

Put Outer Fabric hat inside Snuggles hat so that hats are **wrong sides together**. Align seams and notches and bottom curved edges, pinning together. Zig zag stitch along curved edge to attach layers together.

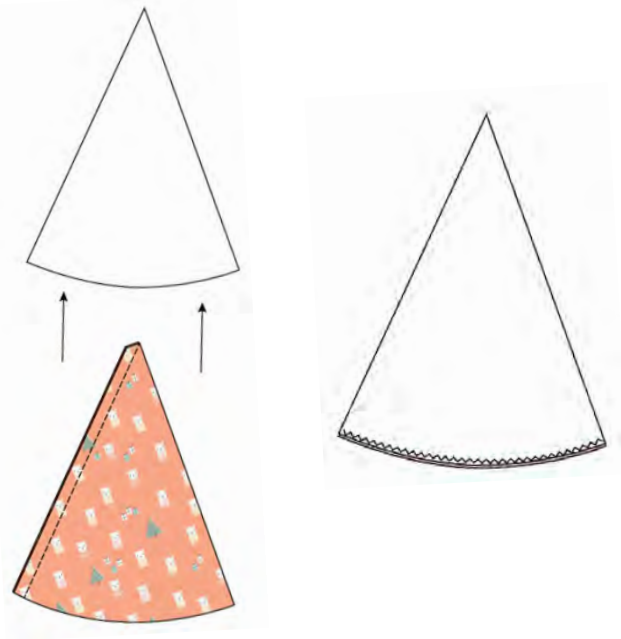

Fold Band in half with RST, aligning short ends. Notch long edges at fold. Stitch short ends together. Trim seam allowance and finger press open. Fold band in half all the way around with **wrong sides together**, aligning raw edges. Zig zag stitch along raw edges all the way around to attach layers together.

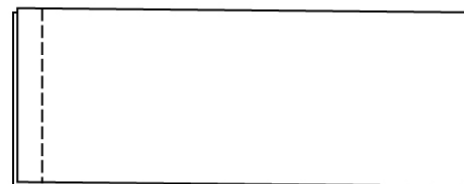

Place band around hat so that it is against Snuggles side and so that zig zagged edges are together. Align and pin at seams and notches. Pin rest of zig zagged edges together, stretching band slightly if necessary to fit hat.

Stitch zig zagged edges of band and hat together, backstitching at beginning and end.

**TIPS:** This is a really thick seam to sew, so lengthen your stitch length to 3.0-4.0 to account for the thickness. If your machine gets caught up, be prepared to **gently** pull the hat through the machine. A walking foot is very useful for this step!

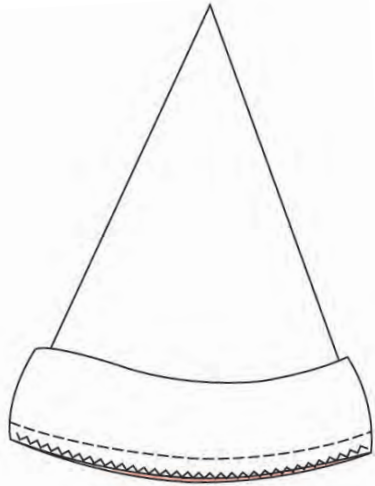

Turn hat right side out. Flip band to outside of hat and fold up to cover seam.

To make pom pom - with an armlength of thread, hand sew a long running stitch around the edge of the pompom circle about 1/4" in from the edge, leaving tails long and unknotted. Pull tails to gather partway. Stuff with fabric scraps or fiber fill.

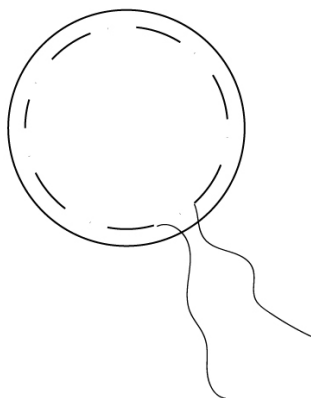

Pull tails to close hole and tie a knot. Thread both tails onto one needle. Sew a loop across the opening, pass the needle through the loop twice, and pull knot tight. Repeat a few more times until pom pom is securely closed.

Use same needle/threads to hand stitch the pom pom to the outside top point of the hat, stitching and knotting in several places to make it secure.



**SIZING TIPS:** This hat is a one-size-fits-most-adults size. For a more custom fit, or to make a kids size, cut and sew the band first, fold it in half lengthwise, and try it on. If it's too big, take in the seam and trim off the extra. Note how much you took it in, and take in the hat the same amount. Voila! Custom fit Santa hat!

## YOU DID IT! YOU MADE A SANTA HAT!!

Be sure to use #rubystarsociety and #RSSsantahat when sharing your creations so we can see them!



1" square  
to check  
print scale

MAIN HAT  
TAPING DIAGRAM

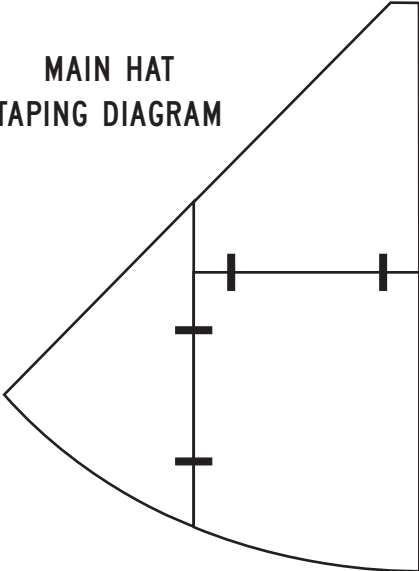

★ RUBY STAR ★  
SOCIETY

SANTA HAT PROJECT SHEET

Hat

Cut 1 on fold - Outer Fabric

Cut 1 on fold - Snuggles

FOLD



align stars and tape together first





align stars and tape together first



align hearts and tape together second



**FOLD**

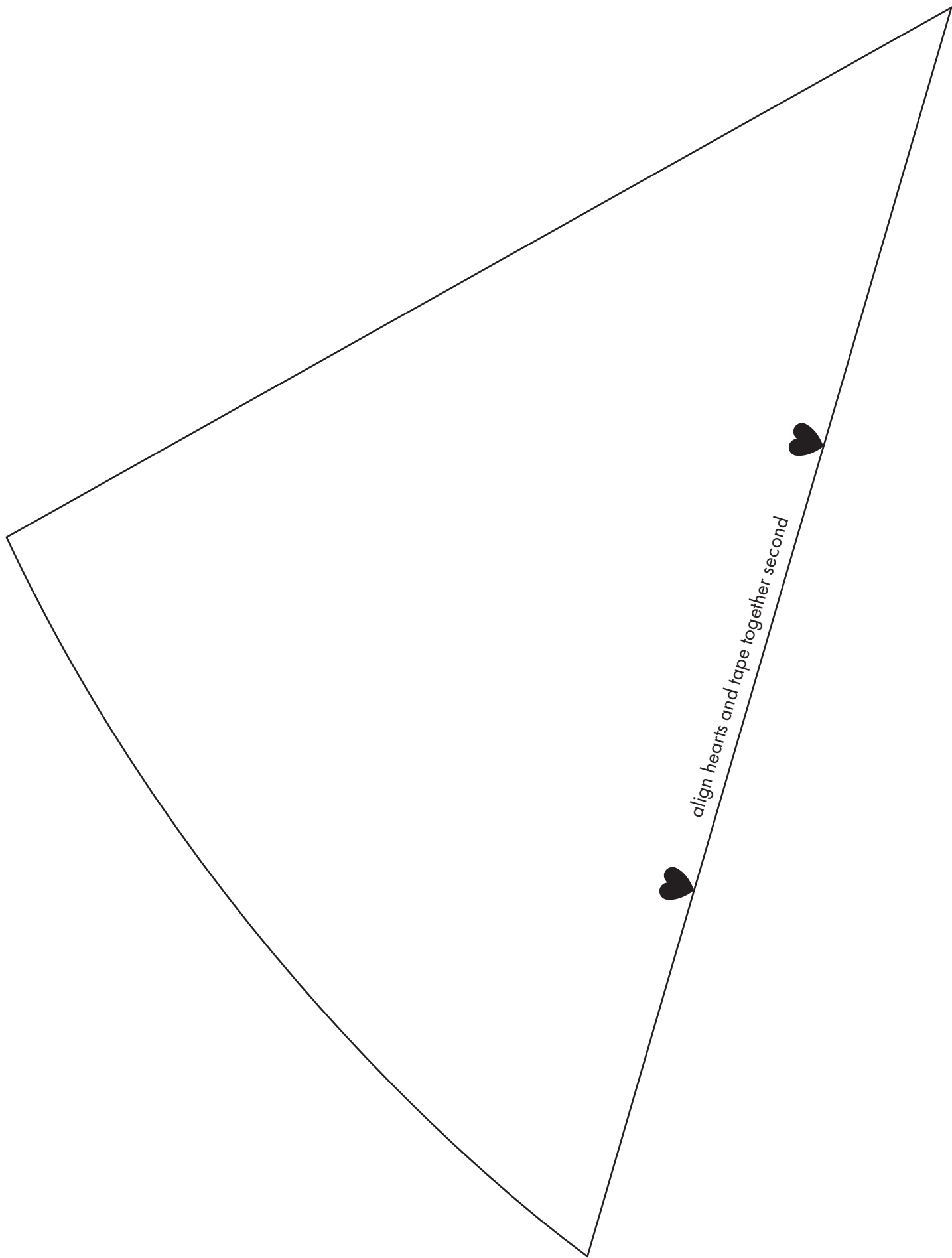

1" square  
to check  
print scale

★ **RUBY STAR** ★  
**SOCIETY**  
**SANTA HAT PROJECT SHEET**  
Pom Pom  
Cut 1 - Snuggles

# SANTA HAT

With just ½ yard of fabric and fleece you can make a cute and festive Santa Hat! Size is one-size-fits-most-adult. Tips for custom fitting and making kids' size inside.

Fabric shown is Snow Bears by Sarah Watts, from Flurry by Ruby Star Society.



## FABRIC REQUIREMENTS

### OUTER FABRIC



RS5028-12 or other Flurry print of choice  
½ yd

### LINING/ACCENT FABRIC



60000-15 Moda Snuggles 60" fabric - white  
½ yd

**ADDITIONAL SUPPLIES:** fabric scraps or fiber fill for stuffing pom pom

★ RUBY STAR  
SOCIETY ★

*moda*  
FABRICS + SUPPLIES

PS RS5028  
7 52106 54829 9

Copyright 2020 Ruby Star Society. Copying or otherwise redistributing is strictly prohibited. For personal use only.